



# Refrigerator

---

## User manual

---

Free Standing Appliance

**SAMSUNG**



# Contents

---

<b>Safety information</b>	<b>3</b>
Important safety symbols and precautions	6
Severe warning signs for transportation and site	7
Critical installation warnings	7
Installation cautions	11
Critical usage warnings	12
Usage cautions	17
Cleaning cautions	19
Critical disposal warnings	21
Additional tips for proper usage	22
Saving Energy Tips	24
This appliance is intended to be used in household and similar applications such as	25
Instructions about the WEEE	25
<b>Installation</b>	<b>26</b>
Refrigerator at a glance	26
Step-by-step installation	28
<b>Operations</b>	<b>33</b>
Main panel	33
SmartThings (applicable models only)	37
Special features	40
<b>Maintenance</b>	<b>45</b>
Handle and care	45
Cleaning	47
Replacement	48
<b>Troubleshooting</b>	<b>49</b>
General	49
Do you hear abnormal sounds from the refrigerator?	51
SmartThings (applicable models only)	53
<b>Open Source Announcement</b>	<b>54</b>



## Safety information

---

- Before using your new Samsung Refrigerator, please read this manual thoroughly to ensure that you know how to operate the features and functions that your new appliance offers safely and efficiently.
- This appliance is not intended for use by persons (including children) with reduced physical, sensory, or mental capabilities, or those who lack experience and knowledge, unless they have been given supervision or instruction concerning the use of the appliance by a person responsible for their safety.
- This appliance can be used by children aged from 8 years and above and persons with reduced physical, sensory or mental capabilities or lack of experience and knowledge if they have been given supervision or instruction concerning use of the appliance in a safe way and understand the hazards involved.  
Children shall not play with the appliance. Cleaning and user maintenance shall not be made by children without supervision.
- Warnings and Important Safety Instructions in this manual do not cover all possible conditions and situations that may occur.  
It is your responsibility to use common sense, caution, and care when installing, maintaining, and operating your appliance.

## Safety information

---

- Because these following operating instructions cover various models, the characteristics of your refrigerator may differ slightly from those described in this manual and not all warning signs may be applicable. If you have any questions or concerns, contact your nearest service center or find help and information online at [www.samsung.com](http://www.samsung.com).
- R-600a or R-134a is used as a refrigerant. Check the compressor label on the rear of the appliance or the rating label inside the fridge to see which refrigerant is used for your refrigerator. When this product contains flammable gas (Refrigerant R-600a), contact your local authority in regard to safe disposal of this product.
- In order to avoid the creation of a flammable gas-air mixture if a leak in the refrigerating circuit occurs, the size of the room in which the appliance may be sited depends on the amount of refrigerant used.
- Never start up an appliance showing any signs of damage. If in doubt, consult your dealer. The room must be 1 m<sup>3</sup> in size for every 8 g of R-600a refrigerant inside the appliance. The amount of refrigerant in your particular appliance is shown on the identification plate inside the appliance.
- Refrigerant squirting out of the pipes could ignite or cause an eye injury. When refrigerant leaks from the pipe, avoid any naked flames and move anything flammable away from the product and ventilate the room immediately.
  - Failing to do so may result in fire or explosion.
- It is hazardous for anyone other than an Authorized Service Person to service this appliance.

- Do not store explosive substances such as aerosol cans with a flammable propellant in this appliance.
- To avoid contamination of food, please respect the following instructions:
  - Opening the door for long periods can cause a significant increase of the temperature in the compartments of the appliance.
  - Clean regularly surfaces that can come in contact with food and accessible drainage systems.
  - Clean water tanks if they have not been used for 48 h; flush the water system connected to a water supply if water has not been drawn for 5 days.
  - Store raw meat and fish in suitable containers in the refrigerator, so that it is not in contact with or drip onto other food.
  - Two-star frozen-food compartments are suitable for storing pre-frozen food, storing or making icecream and making ice cubes.
  - One-, two- and three-star compartments are not suitable for the freezing of fresh food.
  - If the refrigerating appliance is left empty for long periods, switch off, defrost, clean, dry, and leave the door open to prevent mould developing within the appliance.



**WARNING; Risk of fire / flammable materials**



# Safety information

---

## Important safety symbols and precautions

---

Please follow all safety instructions in this manual. This manual uses the following safety symbols.

### **WARNING**

Hazards or unsafe practices that may result in **severe personal injury, property damage, and/or death.**

### **CAUTION**

Hazards or unsafe practices that may result in **severe personal injury and/or property damage.**

### **NOTE**

Useful information that helps users understand or benefit from the refrigerator.

These warning signs are here to prevent injury to you and others.

Please follow them carefully.

After reading this section, keep it in a safe place for future reference.



---

## Severe warning signs for transportation and site

---

### **WARNING**

- When transporting and installing the appliance, care should be taken to ensure that no parts of the refrigerating circuit are damaged.
  - Refrigerant leaking from the pipe work could ignite or cause an eye injury. If a leak is detected, avoid any naked flames or potential sources of ignition and air the room in which the appliance is standing for several minutes.
  - This appliance contains a small amount of isobutane refrigerant (R-600a), a natural gas with high environmental compatibility that is, however, also combustible. When transporting and installing the appliance, care should be taken to ensure that no parts of the refrigerating circuit are damaged.

## Critical installation warnings

---

### **WARNING**

- Do not install the refrigerator in a damp location or place where it may come in contact with water.
  - Deteriorated insulation on electrical parts may cause an electric shock or fire.
- Do not place this refrigerator in direct sunlight or expose it to the heat from stoves, room heaters, or other appliances.

## Safety information

---

- Do not plug several appliances into the same multiple power strip. The refrigerator should always be plugged into its own individual electrical outlet which has a voltage rating that matches the voltage listed on the refrigerator's rating plate.
  - This provides the best performance and also prevents overloading of house wiring circuits, which could cause a fire hazard from overheated wires.
- If the wall socket is loose, do not insert the power plug.
  - There is a risk of electric shock or fire.
- Do not use a power cord that has cracks or abrasion damage along its length or at either end.
- Do not bend the power cord excessively or place heavy objects on it.
- Do not pull or excessively bend the power cord.
- Do not twist or tie the power cord.
- Do not hook the power cord over a metal object, place a heavy object on the power cord, insert the power cord between objects, or push the power cord into the space behind the appliance.
- When moving the refrigerator, be careful not to roll over or damage the power cord.
  - This may result in an electric shock or fire.
- Never unplug your refrigerator by pulling on the power cord. Always grip the plug firmly and pull straight out from the outlet.
  - Damage to the cord may cause a short-circuit, fire, and/or electric shock.
- Do not store explosive substances such as aerosol cans with a flammable propellant in this appliance.



- 
- Do not install this appliance near a heater or inflammable material.
  - Do not install this appliance in a location where gas may leak.
    - This may result in an electric shock or fire.
  - This refrigerator must be properly located and installed in accordance with the instructions in this manual before you use it.
  - Connect the power plug in the proper position with the cord hanging down.
    - If you connect the power plug upside down, the wire can get cut off and cause a fire or electric shock.
  - Make sure that the power plug is not crushed or damaged by the back of the refrigerator.
  - Keep the packing materials out of reach of children.
    - There is a risk of death from suffocation if a child puts the packing materials on his or her head.
  - The appliance must be positioned so that the plug is accessible after installation.
    - Failing to do so may result in an electric shock or fire due to electric leakage.
  - Do not install this appliance in a humid, oily or dusty location, in a location exposed to direct sunlight and water (rain drops).
    - Deteriorated insulation of electrical parts may cause an electric shock or fire.
  - If any dust or water is in the refrigerator, pull out power plug and contact your Samsung Electronics service center.
    - Otherwise there is a risk of fire.

## Safety information

---

- Do not stand on top of the appliance or place objects (such as laundry, lighted candles, lighted cigarettes, dishes, chemicals, metal objects, etc.) on the appliance.
  - This may result in an electric shock, fire, problems with the product, or injury.
- You need to remove all the protective plastic film before you initially plug the product in.
- Children should be supervised to ensure that they do not play with the snap rings used for door adjustment or the water tube clips.
  - There is risk of death by suffocation if a child swallows a snap ring or water tube clip. Keep the snap rings and water tube clips out of children's reach.
- The refrigerator must be safely grounded.
  - Always make sure that you have grounded the refrigerator before attempting to investigate or repair any part of the appliance. Power leakages can cause severe electric shock.
- Never use gas pipes, telephone lines, or other potential lightning attractors as an electrical ground.
  - You must ground the refrigerator to prevent any power leakages or electric shocks caused by current leakage from the refrigerator.
  - This may result in an electric shock, fire, explosion, or problems with the product.
- Plug the power plug into the wall socket firmly. Do not use a damaged power plug, damaged power cord, or loose wall socket.
  - This may result in an electric shock or fire.

- If the power cord is damaged, have it replaced immediately by the manufacturer or one of its service agents.
- The fuse on the refrigerator must be changed by a qualified technician or service company.
  - Failing to do so may result in an electric shock or personal injury.
- When positioning the appliance, ensure the supply cord is not trapped or damaged.
- Do not locate multiple portable socket-outlets or portable power supplies at the rear of the appliance.

## Installation cautions

### CAUTION

- Allow sufficient space around the refrigerator and install it on a flat surface.
  - Keep the ventilation space in the appliance enclosure or mounting structure clear of obstructions.
- Allow the appliance to stand for 2 hours before loading foods after installation and turning on.
- We strongly recommend you have a qualified technician or service company install the refrigerator.
  - Failing to do so may result in an electric shock, fire, explosion, problems with the product, or injury.
- Overload on any one door may fell the refrigerator, causing physical injury.

# Safety information

---

## Critical usage warnings

---

### **WARNING**

- Do not insert the power plug into a wall socket with wet hands.
  - This may result in an electric shock.
- Do not store articles on the top of the appliance.
  - When you open or close the door, the articles may fall and cause personal injury and/or material damage.
- Do not insert hands, feet or metal objects (such as chopsticks, etc.) into the bottom or the back of the refrigerator.
  - This may result in an electric shock or injury.
  - Any sharp edges may cause a personal injury.
- Do not touch the inside walls of the freezer or products stored in the freezer with wet hands.
  - This may cause frostbite.
- Do not put a container filled with water on the refrigerator.
  - If spilled, there is a risk of fire or electric shock.
- Do not keep volatile or flammable objects or substances (benzene, thinner, propane gas, alcohol, ether, LP gas, and other such products) in the refrigerator.
  - This refrigerator is for storing food only.
  - This may result in fire or explosion.
- Children should be supervised to ensure that they do not play with the appliance.
  - Keep fingers out of “pinch point” areas. Clearances between the doors and cabinet are necessarily small. Be careful when you open the doors if children are in the area.

- 
- Do not let children hang on the door or door bins. A serious injury may occur.
  - Do not let children go inside the refrigerator. They could become trapped.
  - Do not insert your hands into the bottom area under the appliance.
    - Any sharp edges may cause personal injury.
  - Do not store pharmaceutical products, scientific materials, or temperature sensitive products in the refrigerator.
    - Products that require strict temperature controls must not be stored in the refrigerator.
  - Do not place or use electrical appliance inside the refrigerator/freezer, unless they are of a type recommended by the manufacturer.
  - If you smell pharmaceutical or smoke, pull out power plug immediately and contact your Samsung Electronics service center.
  - If any dust or water is in Refrigerator, pull out power plug and contact your Samsung Electronics service center.
    - Otherwise there is a risk of fire.
  - Do not let children step on a drawer.
    - The drawer may break and cause them to slip.
  - Do not leave the doors of the refrigerator open while the refrigerator is unattended and do not let children enter inside the refrigerator.
  - Do not allow babies or children go inside the drawer.
    - It can cause death from suffocation by entrapment or personal injury.

## Safety information

---

- Do not overfill the refrigerator with food.
  - When you open the door, an item may fall out and cause personal injury or material damage.
- Do not spray volatile material such as insecticide onto the surface of the appliance.
  - As well as being harmful to humans, it may also result in an electric shock, fire, or problems with the product.
- Do not use or place any substances sensitive to temperature such as flammable sprays, flammable objects, dry ice, medicine, or chemicals near or inside of the refrigerator.
- Do not use a hair dryer to dry the inside of the refrigerator. Do not place a lighted candle in the refrigerator for removing bad odours.
  - This may result in an electric shock or fire.
- Do not stand on top of the appliance or place objects (such as laundry, lighted candles, lighted cigarettes, dishes, chemicals, metal objects, etc.) on the appliance. This may result in an electric shock, fire, problems with the product, or injury. Do not put a container filled with water on the appliance.
  - If spilled, there is a risk of fire or electric shock.
- Do not use mechanical devices or any other means to accelerate the defrosting process, other than those recommended by the manufacturer.
- Do not damage the refrigerant circuit.
- Never stare directly at the UV LED lamp for long periods of time.
  - This may result in eye strain due to the ultraviolet rays.

- 
- Do not put fridge shelf in upside down. Shelf stopper could not work.
    - It may cause a personal injury because of glass shelf drop.
  - If a gas leak is detected, avoid any naked flames or potential sources of ignition, and air the room in which the appliance is standing for several minutes.
    - Do not touch the appliance or power cord.
    - Do not use a ventilating fan.
    - A spark may result in explosion or fire.
  - Use only the LED Lamps provided by the manufacturer or its service agents.
  - Bottles should be stored tightly together so that they do not fall out.
  - This product is intended only for the storage of food in a domestic environment.
  - Do not attempt to repair, disassemble, or modify the refrigerator yourself.
    - Unauthorized modifications can cause safety problems.  
To reverse an unauthorized modification, we will charge the full cost of parts and labor.
  - Do not use any fuse (such as cooper, steel wire, etc.) other than a standard fuse.
  - If your refrigerator needs to be repaired or reinstalled, contact your nearest service center.
    - Failing to do so may result in an electric shock, fire, problems with the product, or injury.
  - If the interior or exterior LED lamp has gone out, contact your nearest service center.

## Safety information

---

- If the refrigerator emits a burning smell or smoke, unplug the refrigerator immediately and contact your Samsung Electronics service center.
  - Failing to do so may result in an electric or fire hazards.
- Pull the power plug out of the socket before changing the interior lamps of the refrigerator.
  - Otherwise, there is a risk of electric shock.
- If you experience difficulty changing a non-LED light, contact a Samsung service center.
- If the product is equipped with LED lamps, do not disassemble the Lamp Covers and LED lamps yourself.
  - Contact a Samsung service center.
- Plug the power plug into the wall socket firmly.
- Do not use a damaged power plug, damaged power cord or loose wall socket.
  - This may result in an electric shock or fire.



---

## Usage cautions

---

### CAUTION

- Do not re-freeze frozen foods that have thawed completely. Do not place carbonated or fizzy drinks in the freezer compartment. Do not put bottles or glass containers in the freezer.
  - When the contents freeze, the glass may break and cause personal injury.
- To get the best performance from the product:
  - Do not place food too close to the vents at the rear of the refrigerator as this can obstruct free air circulation in the refrigerator compartment.
  - Wrap food up properly or place it in airtight containers before putting it into the refrigerator.
  - Please observe maximum storage times and expiration dates of frozen goods.
- Do not place glass or bottles or carbonated beverages into the freezer.
  - The container may freeze and break, and this may result in injury.
- Do not place carbonated or fizzy drinks in the freezer compartment. Do not put bottles or glass containers in the freezer.
  - When the contents freeze, the glass may break and cause personal injury and property damage.

## Safety information

---

- Service Warranty and Modification.
  - Any changes or modifications performed by a 3rd party on this finished appliance are not covered under Samsung warranty service, nor is Samsung responsible for safety issues that result from 3rd party modifications.
- Do not block the air vents inside the refrigerator.
  - If the air vents are blocked, especially with a plastic bag, the refrigerator can be over cooled. If a cooling period lasts too long, the water filter may break and cause water leakage.
- Wipe excess moisture from the inside and leave the doors open.
  - Otherwise, odor and mold may develop.
- If the refrigerator is disconnected from the power supply, you should wait for at least five minutes before plugging it back in.
- When the refrigerator got wet by water, pull out the power plug and contact your Samsung Electronics service center.
- Do not strike or apply excessive force to any glass surface.
  - Broken glass may result in a personal injury and/or property damage.
- Be careful that your fingers are not caught in.
- The lamps in the freezer and refrigerator can be turned off if the doors of the freezer and refrigerator are left open for 2 seconds or longer.
  - The lamps will turn back on when the doors are closed and opened again.

- If the refrigerator is flooded, make sure to contact your nearest service center.
  - There is a risk of electric shock or fire.
- Do not keep vegetable oil in your refrigerator's door bins. The oil can solidify, making it foul-tasting and difficult to use. In addition, the open container can leak and the leaked oil can cause the door bin to crack. After opening an oil container, it is best to keep the container in a cool and shaded place such as a cupboard or pantry.
  - Examples of vegetable oil: olive oil, corn oil, grape-seed oil, etc.

## Cleaning cautions

### CAUTION

- Do not spray water directly on the inside or outside the refrigerator.
  - There is a risk of fire or electric shock.
- Do not use a hair dryer to dry the inside of the refrigerator.
- Do not place a lighted candle in the refrigerator to remove bad odors.
  - This may result in an electric shock or fire.
- Do not spray cleaning products directly on the display.
  - Printed letters on the display may come off.
- If any foreign substance such as water has entered the appliance, unplug the power plug and contact your nearest service center.
  - Failing to do so may result in an electric shock or fire.

## Safety information

---

- Use a clean, dry cloth to remove any foreign matter or dust from the power plug blades. Do not use a wet or damp cloth when cleaning the plug.
  - Otherwise, there is a risk of fire or electric shock.
- Do not clean the appliance by spraying water directly onto it.
- Do not use benzene, thinner, or Clorox, Chloride for cleaning.
  - They may damage the surface of the appliance and may cause a fire.
- Before cleaning or performing maintenance, unplug the appliance from the wall socket.
  - Failing to do so may result in an electric shock or fire.
- Use a clean sponge or soft cloth and a mild detergent in warm water to clean the refrigerator.
- Do not use abrasive or harsh cleansers such as window sprays, scouring cleansers, flammable fluids, muriatic acid, cleaning waxes, concentrated detergents, bleaches, or cleansers containing petroleum products on exterior surfaces (doors and cabinet), plastic parts, door and interior liners, and gaskets.
  - These can scratch or damage the material.
- Do not clean glass shelves or covers with warm water when they are cold. Glass shelves and covers may break if exposed to sudden temperature changes or impacts such as bumping or dropping.

---

## Critical disposal warnings

---

### **WARNING**

- Please dispose of the packaging material from this product in an environmentally friendly manner.
- Ensure that none of the pipes on the back of the refrigerator are damaged prior to disposal.
- R-600a or R-134a is used as a refrigerant. Check the compressor label on the rear of the appliance or the rating label inside the fridge to see which refrigerant is used for your refrigerator. If this refrigerator contains flammable gas (Refrigerant R-600a), contact your local authority in regard to safe disposal of this product.
- When disposing of this refrigerator, remove the door/door seals and door latch so that small children or animals cannot become trapped inside. Children should be supervised to ensure that they do not play with the appliance. If trapped inside, a child may get hurt or suffocate to death.
- Cyclopentane is used in the insulation. The gases in the insulation material require a special disposal procedure. Please contact your local authorities in regard to the environmentally safe disposal of this product.
- Keep all packaging materials well out of the reach of children, as packaging materials can be dangerous to children.
  - If a child places a bag over his or her head, the child could suffocate.

## Safety information

---

- DANGER: Risk of child entrapment. Before you throw away your old refrigerator or freezer:
  - Take off the doors.
  - Leave the shelves in place so that children may not easily climb inside.

### Additional tips for proper usage

---

- In the event of a power failure, call the local office of your electric company and ask how long the failure is going to last.
  - Most power failures that are corrected in an hour or two will not affect your refrigerator temperatures. However, you should minimize the number of door openings while the power is off.
  - Should the power failure last more than 24 hours, remove and discard all frozen food.
- The refrigerator might not operate consistently (frozen contents can thaw or temperatures can become too warm in the frozen food compartment) if sited for an extended period of time in a location where ambient air temperatures are constantly below the temperatures for which the appliance is designed.
- In case of particular foods, keeping it under refrigeration can have a bad effect on preservation due to its properties.
- Your appliance is frost free, which means there is no need to manually defrost your appliance. This will be carried out automatically.

- 
- Temperature rise during defrosting complies with ISO requirements. If you want to prevent an undue rise in the temperature of frozen food while the appliance defrosts, wrap the frozen food in several layers of newspaper.
  - Do not re-freeze frozen foods that have thawed completely.
  - The temperature of two star section (sections) or compartment (compartments) which have two star symbol (☆☆) is slightly higher than other freezer compartment (compartments).  
The two star section (sections) or compartment (compartments) is (are) based on the instruction and/or the condition as delivered.

# Safety information

---

## Saving Energy Tips

---

- Install the appliance in a cool, dry room with adequate ventilation. Ensure that it is not exposed to direct sunlight and never put it near a direct source of heat (a radiator, for example).
- Not to block any vents and grilles is recommended for energy efficiency.
- Allow warm food to cool down before placing it in the appliance.
- Put frozen food in the refrigerator to thaw. You can then use the low temperatures of the frozen products to cool food in the refrigerator.
- Do not keep the door of the refrigerator open for too long when putting food in or taking food out. The shorter the time the door is open, the less frost build-up you'll have in the freezer.
- It is recommended to install the refrigerator with clearance to the back and sides. This will help reduce power consumption and keep your energy bills lower.
- For the most efficient use of energy, please keep the all inner fittings such as baskets, drawers, shelves on the position supplied by manufacturer.



---

## This appliance is intended to be used in household and similar applications such as

---

- staff kitchen areas in shops, offices and other working environments;
- farm houses and by clients in hotels, motels and other residential type environments;
- bed and breakfast type environments;
- catering and similar non-retail applications.

---

## Instructions about the WEEE

---



### Correct Disposal of This Product (Waste Electrical & Electronic Equipment) (Applicable in countries with separate collection systems)

This marking on the product, accessories or literature indicates that the product and its electronic accessories (e.g. charger, headset, USB cable) should not be disposed of with other household waste at the end of their working life. To prevent possible harm to the environment or human health from uncontrolled waste disposal, please separate these items from other types of waste and recycle them responsibly to promote the sustainable reuse of material resources.

Household users should contact either the retailer where they purchased this product, or their local government office, for details of where and how they can take these items for environmentally safe recycling.

Business users should contact their supplier and check the terms and conditions of the purchase contract. This product and its electronic accessories should not be mixed with other commercial wastes for disposal.

For information on Samsung's environmental commitments and product regulatory obligations, e.g. REACH, WEEE or Batteries, visit our sustainability page available via [www.samsung.com](http://www.samsung.com)

(For products sold in European countries and in the UK only)

# Installation

Follow these instructions carefully to ensure a proper installation of this refrigerator and to prevent accidents before using it.

## ⚠ WARNING

- Use the refrigerator only for its intended purpose as described in this manual.
- Any servicing must be performed by a qualified technician.
- Dispose of the product packaging material in compliance with local regulations.

## Refrigerator at a glance

### 📖 NOTE

The actual image and provided parts of the refrigerator may differ, depending on the model and the country.

Auto Ice Maker model

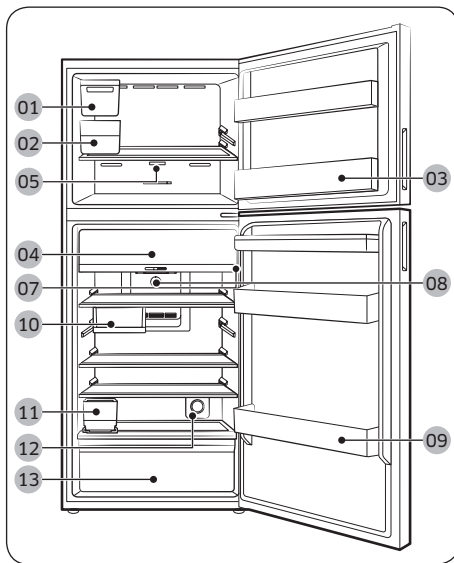

Dispenser model

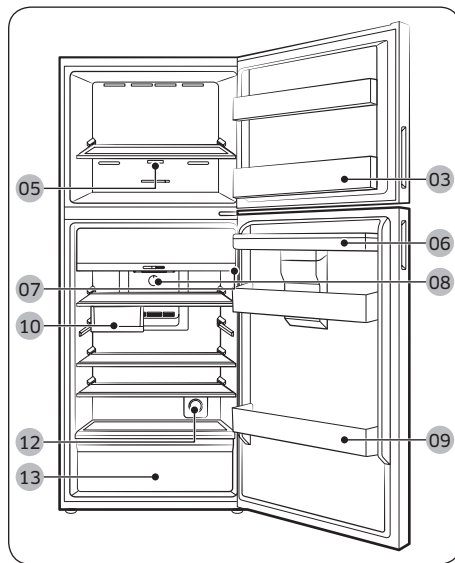



- |   |  |
|---|--|
| <b>01</b> Auto Ice Maker ***                | <b>02</b> Ice bucket ***                   |
| <b>03</b> Freezer door bin                  | <b>04</b> Optimal Fresh Zone *             |
| <b>05</b> Main panel (Analogue - Freezer) * | <b>06</b> Water tank for Dispenser **      |
| <b>07</b> Main panel (Digital - Fridge) *   | <b>08</b> Main panel (Analogue - Fridge) * |
| <b>09</b> Fridge door bin                   | <b>10</b> Multi Tray *                     |
| <b>11</b> Water tank for Auto Ice Maker *** | <b>12</b> Active Fresh Filter *            |
| <b>13</b> Vegetable drawer                  |  |

\* applicable models only

\*\* Dispenser models only

\*\*\* Auto Ice Maker models only

### To secure more room for storage in the freezer compartment

Remove one or more optional accessories such as shelf (or shelves), twist ice maker(s), ice storage bin(s), ice bucket(s) and their supports, all of which can be removed manually without a tool.

- These optional accessories do not affect thermal and mechanical performance.
- A declared storage volume of the freezer is based on the nonexistence of those optional accessories.
- For best energy efficiency, make sure all shelves and drawers are placed in their original position.

### Load limit indicator (applicable models only)

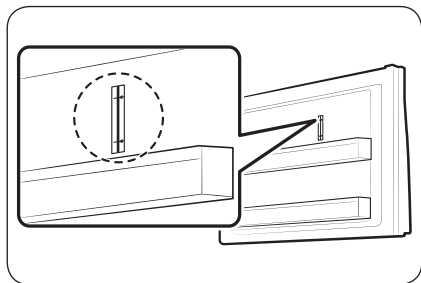

The refrigerator has a load limit indicator on the top right side of the freezer compartment.

#### ⚠ CAUTION

- Do not put or keep food items over the load limit indicator. Otherwise, energy efficiency may be affected.



# Installation

## Step-by-step installation

### STEP 1 Select a site

#### Site requirements:

- Solid, level surface without carpeting or flooring that may obstruct ventilation
- Away from direct sunlight
- Adequate room for opening and closing the door
- Away from a heat source
- Room for maintenance and servicing
- Temperature range: between 10 °C and 43 °C

#### Effective temperature range

The refrigerator is designed to operate normally in the temperature range specified by its class rating.

Class	Symbol	Ambient Temperature range (°C)	
		IEC 62552 (ISO 15502)	ISO 8561
Extended Temperate	SN	+10 to +32	+10 to +32
Temperate	N	+16 to +32	+16 to +32
Subtropical	ST	+16 to +38	+18 to +38
Tropical	T	+16 to +43	+18 to +43

#### NOTE

The cooling performance and power consumption of the refrigerator may be affected by the ambient temperature, the door-opening frequency, and the location of the refrigerator. We recommend adjusting the temperature settings as appropriate.

## Clearance

See the pictures and table below for space requirements for installation.

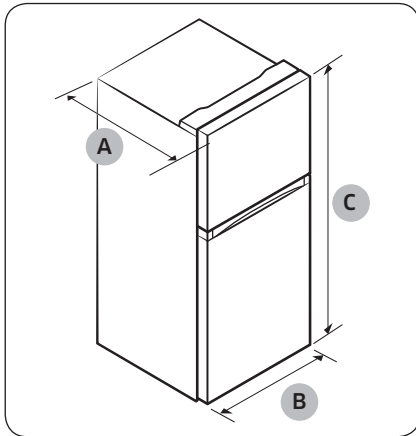

Model	RT31	RT35	RT38
Depth "A"	647	709	672
Width "B"	600	600	700
Height "C"	1715	1715	1715

(unit : mm)

Model	RT42	RT47
Depth "A"	672	717
Width "B"	700	700
Height "C"	1785	1825

(unit : mm)

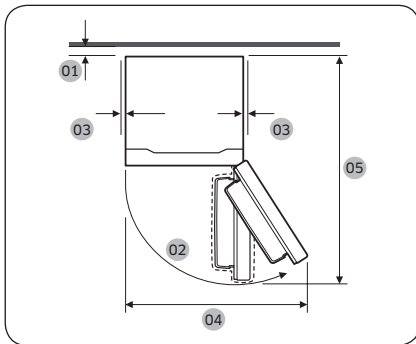

	RT31	RT35	RT38
01	more than 50mm recommended		
02	115° (Freezer) / 115° (Fridge)		
03	At least 50 mm		
04	850	850	1006
05	1201	1263	1311

(unit : mm)

	RT42	RT47
01	more than 50 mm recommended	
02	115° (Freezer) / 115° (Fridge)	
03	At least 50 mm	
04	1006	1006
05	1311	1356

(unit : mm)

# Installation

## STEP 2 Spacing (applicable models only)

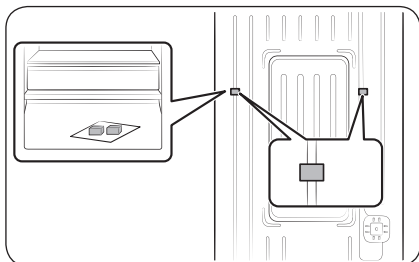

1. Open the door and locate the provided spacers (x2).
2. Unpack both spacers and attach them to the rear of the refrigerator as shown. They help ventilate air to the rear wall and save power consumption.

## STEP 3 Flooring

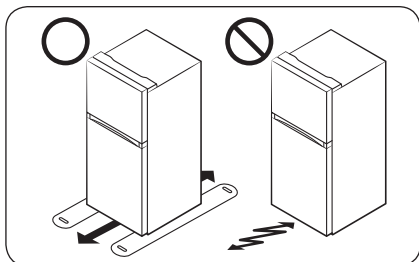

- The surface to install the refrigerator must support a fully loaded refrigerator or approximately 90 kg.
- To protect the floor, put a large piece of cardboard on each leg of the refrigerator.
- Once the refrigerator is in its final position, do not move it unless necessary to protect the floor. If you have to, use thick paper or cloth such as old carpets along the movement path.

## STEP 4 Adjust the levelling feet

### ⚠ CAUTION

- When installed, the refrigerator must be levelled on a flat, solid floor. Not levelling the refrigerator can cause damage to the refrigerator or physical injury.
- Levelling must be performed with the refrigerator empty. Make sure no food items are inside the refrigerator.
- For safety reasons, adjust the front a little higher than the rear. Level the refrigerator using special screws (levellers) on the front legs. Use a flat-head screwdriver to turn the levellers.

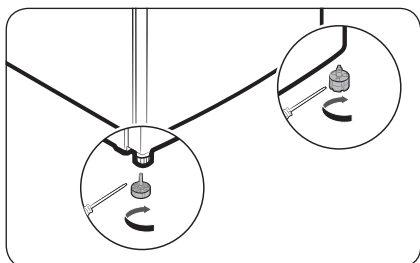

Level the refrigerator by manually adjusting the levelling feet. Turn the levelling feet clockwise to lower the position or turn anticlockwise to raise. For safety reasons, adjust the front side a little higher than the rear side.

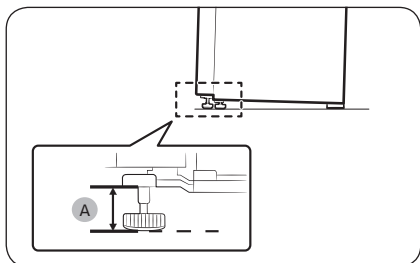

Leave the feet at 41 mm (A) from the floor as shown.

# Installation

---

## STEP 5 Initial settings

---

By completing the following steps, the refrigerator should be fully functioning.

1. Plug the power cord into the wall socket to turn the refrigerator on.
2. Open the door, and check if the interior light lights up.
3. Set the temperature to the coldest, and wait for about an hour. Then, the freezer will be slightly chilled, and the motor will run smoothly.
4. Wait until the refrigerator reaches the set temperature. Now the refrigerator is ready for use.

## STEP 6 Final check

---

When the installation is complete, confirm that:

- The refrigerator is plugged into an electrical outlet and grounded properly.
- The refrigerator is installed on a flat, level surface with a reasonable clearance from the wall or the cabinet.
- The refrigerator is level and is sitting firmly on the floor.
- The door opens and closes freely, and the interior light turns on automatically when you open the door.



# Operations

## Main panel

### Fridge - Digital

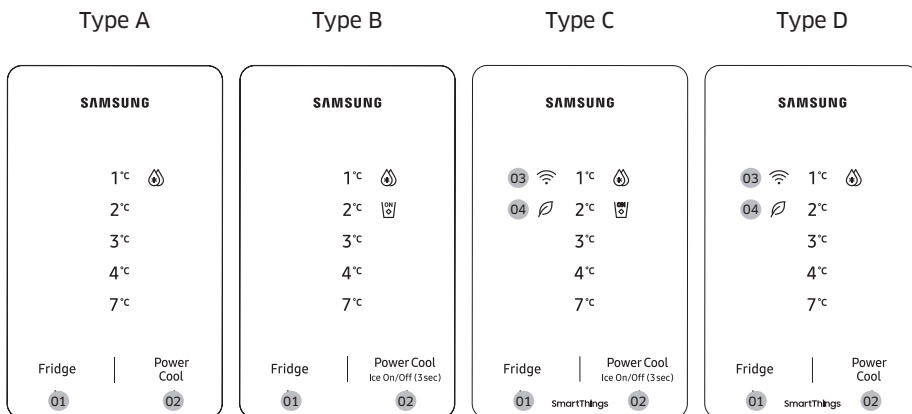

**01** Fridge

**02** Power Cool / Ice On/Off (3 sec) \*

**03** Network connection indicator \*

**04** AI Energy Mode \*

\* applicable models only

#### NOTE

The temperature in the refrigerator may rise if you open the door frequently or put a large amount of food into the refrigerator. If this happens, the all LED that display temperature blinks until the refrigerator returns to the specified temperature settings. If the blinking continues for an extended time, contact a local Samsung service center for technical assistance.



- While the temperature display is blinking, an alarm may occur. To stop the alarm, tap any button on the display.
- If you open the door while the temperature display is blinking, the internal light blinks for about a minute.

#### 01 Fridge

Fridge	<p>Press <b>Fridge</b> to select the desired fridge temperature.</p> <p> <b>CAUTION</b></p> <ul style="list-style-type: none"> <li>• Do not set the fridge temperature to the lowest in winter and highest in summer. It may cause problems with the cooling performance.</li> </ul>
--------	--

# Operations

## 02 Power Cool / Ice On/Off (3 sec)

<b>Power Cool</b>	<p>Press <b>Power Cool</b> to activate or deactivate Power Cool.</p> <ul style="list-style-type: none"><li>• Power Cool speeds up the cooling process at maximum fan speed. The fridge keeps running at full speed for several hours and then returns to the previous temperature.</li><li>• When Power Cool activates, the Power Cool icon (  ) turns on, and the refrigerator will speed up the cooling process for you.</li><li>• To cool large amounts of food completely, activate Power Cool at least 24 hours in advance.</li></ul> <p><b>NOTE</b></p> <p>Using Power Cool increases power consumption. Make sure you turn it off and return to the previous temperature if you do not intend to use it.</p>
<b>Ice On/Off</b> (Type B, C only)	<p>Press and hold <b>Power Cool</b> for 3 seconds to turn the Auto Ice Maker on or off.</p> <ul style="list-style-type: none"><li>• When the Auto Ice Maker is on, the ice maker icon (  ) turns on. The Auto Ice Maker is set to on by default.</li><li>• We recommend disabling the function in the following cases:<ul style="list-style-type: none"><li>- The ice bucket is already full of ice.</li><li>- You want to decrease power consumption.</li></ul></li></ul>

## 03 Network connection (applicable models only)

You can control and monitor your refrigerator on the SmartThings app. For more information, see the **SmartThings (applicable models only)** section.

### **NOTE**



If the refrigerator is not connected to the SmartThings app, the Wi-Fi (  ) icon blinks to alert you when opening the door. If you see the blinking Wi-Fi (  ) icon, we recommend that you connect your refrigerator to the SmartThings app.

## 04 AI Energy Mode (applicable models only)

- The  icon appears when the AI Energy Mode is operating. You may turn on or off the AI Energy Mode in the SmartThings app. (applicable models only)

### Turning the Wi-Fi on or off (applicable models only)

To turn the Wi-Fi on or off, press and hold **Fridge** for 10 seconds. The Wi-Fi (  ) icon shows the status of the Wi-Fi as shown below.

- Wi-Fi Off: The Wi-Fi (  ) icon blinks for 5 seconds and then turns off.
- Wi-Fi On: The Wi-Fi (  ) icon blinks for 5 seconds and then turns on for 5 seconds.

### **NOTE**

- You must turn on the Wi-Fi to connect the refrigerator to the SmartThings app.
- For more information, see the **SmartThings (applicable models only)** section.

## Fridge - Analogue

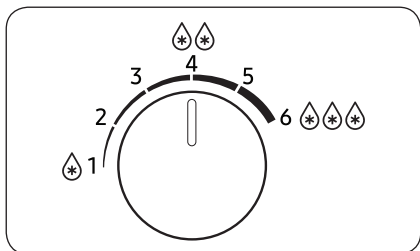

- Turn the dial left and right to set the desired temperature.
- Turn the dial left to raise, and turn it right to lower the temperature.

### NOTE

To ensure optimal performance, we recommend setting the temperature to .

### CAUTION

- Do not set the fridge temperature higher (1-2) when the room temperature is lower than 10 °C, and lower (4-6) when the temperature is higher than 35 °C. It may cause problems with the cooling performance.

# Operations

## Freezer - Analogue

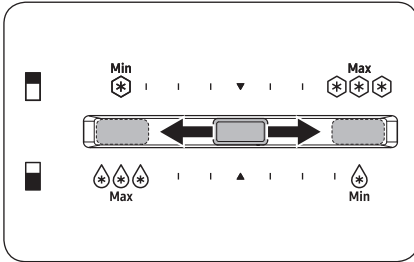

- To increase the temperature, slide the temperature control to the left.
- To decrease the temperature, slide the temperature control to the right. In winter, slide the temperature control to the right-most end.

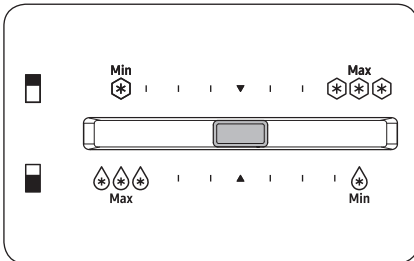

To make ice in summer (above 35 °C), set the freezer temperature to the centre.

### NOTE

If the Auto Ice maker is not making enough ice, slide the temperature control to the right.

### CAUTION

- To prevent system failure or food spoiling, do not set the temperature to the right-most end (maximum) in summer (above 35 °C).
- Do not store glass bottles containing liquid in the freezer. Glass bottles will crack or break into pieces when the liquid freezes.

---

## SmartThings (applicable models only)

---

### Installation

Visit the Google Play Store, Galaxy Apps, or Apple App Store and search for “SmartThings”. Download and install the SmartThings app provided by Samsung Electronics to your smart device.

#### NOTE

- The supporting software version of the SmartThings app is subject to change according to the OS supporting policy the manufacturer provides. In addition, as for the SmartThings app or the functions that the app supports, the new application update policy on the existing OS version can be suspended due to usability or security reasons.
- The SmartThings app is subject to change without notice to improve usability or performance. As the mobile phone OS version is updated every year, the SmartThings is also updated continually according to the latest OS. If you have enquiries regarding the items mentioned above, please contact us at [st.service@samsung.com](mailto:st.service@samsung.com)
- Recommended encryption systems include WPA/TKIP and WPA2/AES. Any newer or non-standard Wi-Fi authentication protocols are not supported.
- Wireless networks may be affected by the surrounding wireless communication environment.
- If your Internet service provider has registered the MAC address of your PC or modem for identification, your Samsung Smart Refrigerator may fail to connect to the Internet. If this happens, contact your Internet service provider for technical assistance.
- The firewall settings of your network system may prevent your Samsung Smart Refrigerator from accessing the Internet. Contact your Internet service provider for technical assistance. If this symptom continues, contact a local Samsung service centre or retailer.
- To configure the wireless access point (AP) settings, see the user manual of the AP Router.
- Samsung Smart Refrigerators support both Wi-Fi 2.4 GHz with IEEE 802.11 b/g/n and Soft-AP protocols. (IEEE 802.11 n is recommended.)
- Unauthorized Wi-Fi wireless routers may fail to connect to applicable Samsung Smart Refrigerators.

# Operations

---

## Samsung account

You are required to register your Samsung account to use the app. If you don't have a Samsung account, follow the app's on-screen instructions to create a free Samsung account.

## Getting started

Turn on the device you want to connect, open the SmartThings app on your phone, and then follow the instructions below.

If a pop-up appears saying that a new device has been found, tap **ADD NOW**.

If a pop-up doesn't appear, tap the **+** button, and then select the device you want to connect from the list of available devices.

If your device isn't in the list of available devices, tap **Supported Devices**, select the device type (Refrigerator), and then select the specific device model.

Follow the instructions in the app to set up your device. Once setup is complete, your refrigerator will appear as a "card" on your **Devices** screen.

## Refrigerator app

### Integrated control

You can monitor and control your refrigerator at home and on the go.

- Tap the refrigerator icon on the SmartThings Dashboard or tap the Devices icon at the bottom of the Dashboard, and then tap the refrigerator "card" to open the Refrigerator page.
- Check the operation status or notifications related to your refrigerator, and then change options or settings if necessary.

### **NOTE**

Some options or settings of the refrigerator may not be available for remote control.

Category	Item	Description
Monitoring	Fridge temperature	Displays the current temperature setting of the fridge.
	Energy monitoring	Checks the accumulated power consumption of the refrigerator for the last 180 days.
Functions	Power Cool	You can turn Power Cool on or off, and check the current settings.
Alarms	Abnormally high temperature	This alarm is triggered when the fridge has abnormally high temperatures.
	Door opening	This alarm is triggered if the fridge or freezer door is open for more than 2 minutes.
AI Energy Mode (applicable models only)	<p>You can turn on or off the AI Energy Mode under the Energy menu in the SmartThings app.</p> <p>You can check the status of the AI Energy Mode on the SmartThings app.</p> <p>On some models, the  icon appears on the main panel to indicate that AI Energy Mode is operating. (applicable models only)</p> <p>Turning on the AI Energy Mode decreases energy consumption, but it may also reduce the cooling performance.</p>	

# Operations

## Special features

The actual image and special functions of your refrigerator may differ, depending on the model and the country.

### Ice making (applicable models only)

#### Twist ice maker (applicable models only)

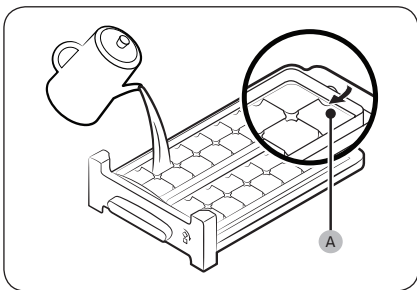

1. Open the freezer door, and slide open the ice tray.
2. Fill the tray with water up to the **maximum level (A)** marked on the inner rear of the tray.
3. Slide the tray back into position.

#### **NOTE**

The ice making time depends on your temperature settings.

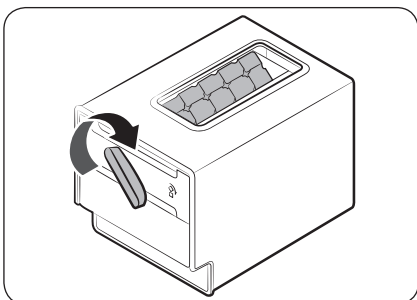

#### **NOTE**

- Make sure the ice cube storage bin is in place under the ice tray.
- To dispense the ice cubes, turn the ice tray handle to the right to empty half of the ice cubes into the bin. Then, turn it to the left to empty the other half.
- To take out the bin, pull it forward.
- Put the twist ice maker on the freezer shelf if it does not fit under the shelf.



## Water tank for Auto Ice Maker (applicable models only)

To fill the water tank (applicable models only)

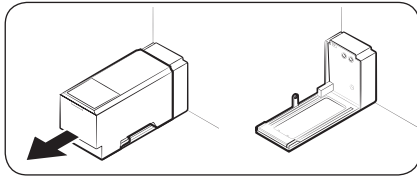

For first-time use, clean the inner side of the water tank and dry well.

1. Hold the handle with both hands, and then pull forward to remove it.

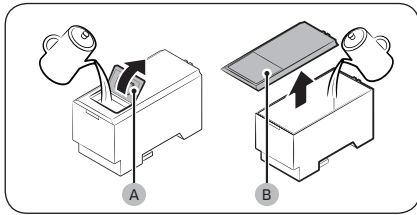

2. Open the lid (A) or the entire cover (B) and fill the tank with water.

### ⚠ CAUTION

Do not exceed the max line. Water overflows.

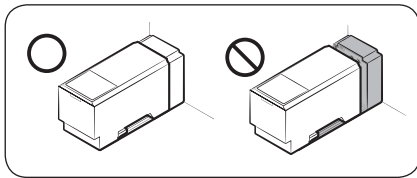

3. Reinsert the water tank and fit it into the dispenser mechanism. Make sure the lid on the cover faces the front.

### ⚠ CAUTION

- Make sure the water tank fits into the shelf. Otherwise, the water tank may not operate properly.
- Fill the tank only with potable water such as mineral or purified water. Do not use other liquids.
- Full water tank is heavy and therefore, use caution when moving a filled tank. Physical injury may occur if the tank is dropped.
- Do not try to disassemble the internal pump yourself. If the internal pump is damaged or disconnected from the water tank, the Auto Ice Maker does not operate.

### 📖 NOTE

If you are not using the Auto Ice Maker, you can remove the water tank for more storage space.

# Operations

## Auto Ice Maker (applicable models only)

The refrigerator has an ice maker that automatically dispenses ice.

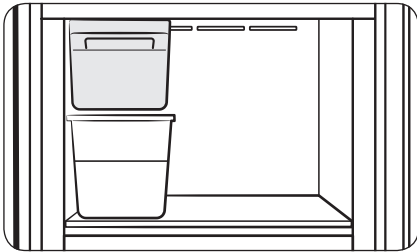

### For first-time use

- Fill the water tank and let the ice maker make ice for 1-2 days.
- Discard the first 1-2 buckets of ice to remove impurities in the water supply system.

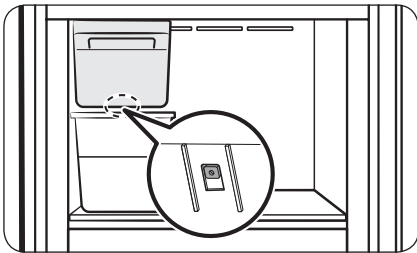

### Diagnosis

If the Auto Ice Maker does not make ice, remove the ice bucket and press the **Test** button to check if the Auto Ice Maker operates properly.

### ⚠ CAUTION

- When the Auto Ice Maker is on, the refrigerator will keep making ice even when you remove the ice bucket. If you are not going to use the Auto Ice Maker, make sure to turn it off.
- When the refrigerator recovers power after a power failure, the ice bucket may contain a mix of melted and jammed ice cubes, which can prevent the ice maker from working properly. To prevent this, make sure to empty the ice bucket before using the refrigerator.
- Do not put fingers or any objects into the ice maker. This can cause physical injury or property damage.
- Due to sublimation, ice stored in the freezer for a long time gets smaller and then forms large ice chunks. Therefore, if it will be a long time before you use ice, turn the ice maker off.

### 📖 NOTE

If you are not using the Auto Ice Maker, you can remove the ice bucket for more storage space.

### Optimal Fresh Zone (applicable models only)

Optimal Fresh Zone is an independently controlled compartment where you can store different items at the optimal temperature.

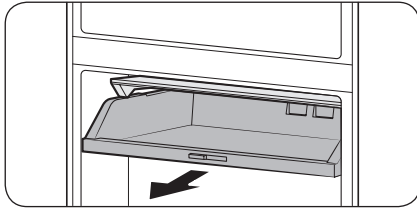

Hold the bottom part of the of the Optimal Fresh Zone and pull to store or take out items.

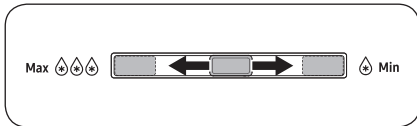

You can adjust the temperature of the Optimal Fresh Zone.

- To increase the temperature, slide the temperature control to the right.
- To decrease the temperature, slide the temperature control to the left.

### Water dispenser (applicable models only)

With the water dispenser, you can dispense water without opening the fridge door. The water tank must be filled with potable water before use.

#### To fill the water tank with potable water

Open the door and locate the water tank that is located in the door bin area.

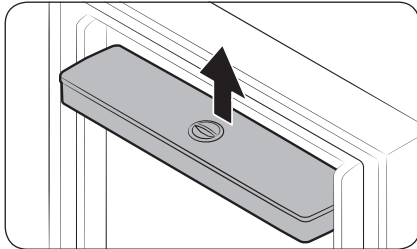

1. Hold both sides of the water tank and lift to remove.

# Operations

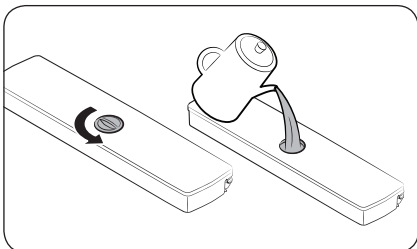

2. Fill the water tank with potable water. Remove the cap and pour water.

## NOTE

Before using the water tank for the first time, clean the water tank thoroughly, especially the nozzle. Regularly clean the water tank and the nozzle.

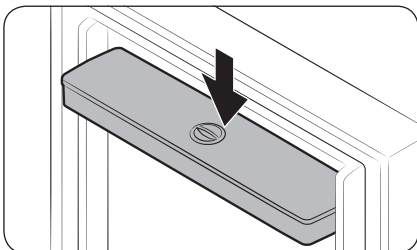

3. Reinsert the water tank and close the door. Make sure the water outlet of the water tank faces forward.

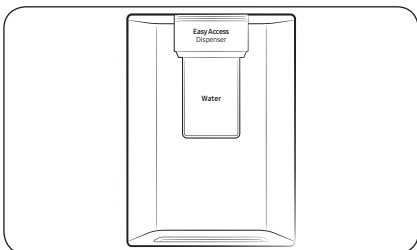

4. Put a water glass under the water outlet of the dispenser, and gently push the dispenser lever to dispense water.

## CAUTION

- The water dispenser is designed to dispense potable water. Fill the water tank only with potable water. Do not fill with any other liquids.
- Do not fill the water tank excessively, which causes an overflow.
- Do not try to fill the water tank without removing it from the door.
- Make sure that water tank is seated properly.
- Do not use the refrigerator without the water tank. This may reduce performance and efficiency.
- To prevent water bouncing, make sure the glass is in line with the dispenser lever.

## NOTE

To secure more room, you can use the water tank to store food. In this case, remove the lid of the tank.

# Maintenance

## Handle and care

### Shelves (fridge/freezer)

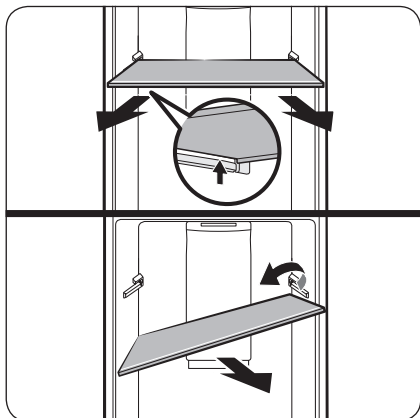

To remove the shelf, hold it with both hands and lift it to release it from the rear hook. Then, tilt it on one side and pull it out.

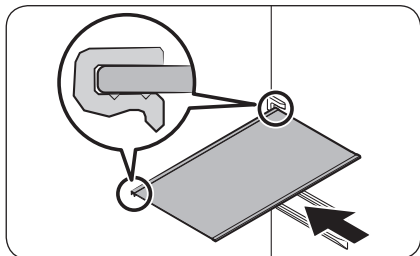

Before you insert the shelf, check the shape of the back of the shelf. Then, insert the shelf in the reverse order of removal.

#### ⚠ CAUTION

- The shelf must be inserted correctly. Do not insert it upside down or back to front.
- Shelves are heavy, therefore be careful when you handle them.

### Vegetable drawer

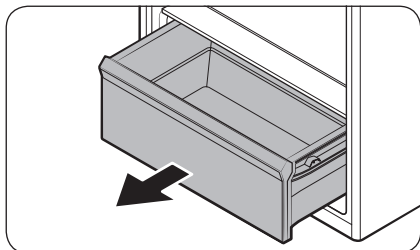

Gently lift up the front of the drawer and slide out.

# Maintenance

## Vegetable shelf

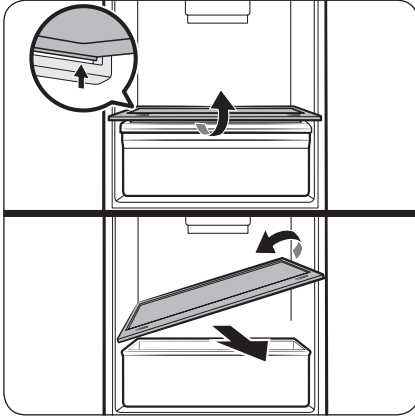

Hold the vegetable shelf with both hands and lift it to release it from the rear hook. Then, tilt it on one side and pull it out.

## Door bins

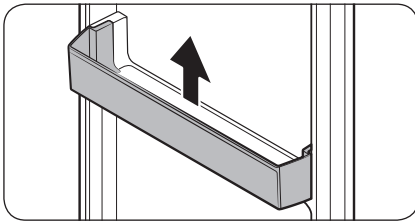

Slightly lift up and pull out the door bins.

**⚠ CAUTION**

To prevent accidents, empty the door bins before removing them.

---

## Cleaning

---

### **WARNING**

- Do not use benzene, thinner, or home/car detergent such as Clorox™ for cleaning purposes. They may damage the surface of the refrigerator and cause a fire.
- Do not spray water onto the refrigerator. This may cause electric shock.

Regularly use a dry cloth to remove all foreign substances such as dust or water from the power plug terminals and contact points.

1. Unplug the power cord of the refrigerator.
2. Use a moistened soft lint-free cloth or paper towel to clean the refrigerator's interior and exterior.
3. When done, use a dry cloth or paper towel to dry well.
4. Plug in the power cord of the refrigerator to turn the refrigerator on.

### **NOTE**

If you have removed any removable parts such as shelves for cleaning, refer to the overall layout in the **Refrigerator at a glance** section to make sure you have reinserted correctly.

# Maintenance

## Replacement

### Deodorizer filter (applicable models only)

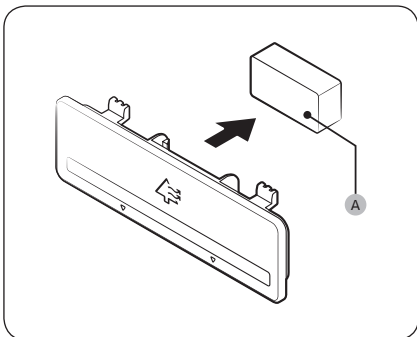

While holding the top and bottom sides of the filter case, unlock the filter case to reveal the **deodorizer filter (A)**. Replace the filter, and then reinsert the case.

### Lamps and active fresh filter

Neither lamps nor the active fresh filter is user-serviceable. Do not attempt to replace them yourself. To replace them, contact a local Samsung service centre.

#### **⚠ WARNING**

- The lamps are not user-serviceable. Do not attempt to replace a lamp yourself. This can cause electric shock.

### Lamp (Light Source)

This product contains a light source of energy efficiency class <G>.

The lamp(s) and/or control gear(s) are not user-serviceable. To replace the lamp(s) and/or control gear(s) in the product, contact a local Samsung service centre.

For detailed instructions on replacing lamp(s) or control gear(s) in your product, visit the Samsung website (<http://www.samsung.com>), go to Support > Support home, and then enter the model name.

For detailed instructions on dismantling lamp(s) and/or control gear(s), simply follow the replacement instruction reached as described above.



# Troubleshooting

Before calling for service, review the checkpoints below. Any service calls regarding normal situations (No Defect Cases) will be charged to users.

## General

### Temperature

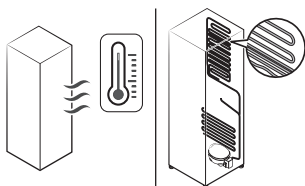
Symptom	Possible causes	Solution
Fridge/freezer does not operate. Fridge/freezer temperature is warm.	<ul style="list-style-type: none"> <li>Power cord is not plugged in properly.</li> </ul>	<ul style="list-style-type: none"> <li>Properly plug in the power cord.</li> </ul>
	<ul style="list-style-type: none"> <li>Temperature control is not set correctly.</li> </ul>	<ul style="list-style-type: none"> <li>Set the temperature lower.</li> </ul>
	<ul style="list-style-type: none"> <li>Refrigerator is located near a heat source or direct sunlight.</li> </ul>	<ul style="list-style-type: none"> <li>Keep the refrigerator away from direct sunlight or a heat source.</li> </ul>
	<ul style="list-style-type: none"> <li>Not enough clearance between refrigerator and sides/rear.</li> </ul>	<ul style="list-style-type: none"> <li>We recommend that the gap between the refrigerator and nearby walls (or cabinets) is more than 50 mm.</li> </ul>
	<ul style="list-style-type: none"> <li>Vacation mode is activated.</li> </ul>	<ul style="list-style-type: none"> <li>Deactivate vacation mode.</li> </ul>
	<ul style="list-style-type: none"> <li>The refrigerator is overloaded. Food is blocking the refrigerator vents.</li> </ul>	<ul style="list-style-type: none"> <li>Do not overload the refrigerator. Do not allow food to block ventilation.</li> </ul>
Fridge/freezer is over-cooling.	<ul style="list-style-type: none"> <li>Temperature control is not set correctly.</li> </ul>	<ul style="list-style-type: none"> <li>Set the temperature higher.</li> </ul>
Interior wall is hot.	<ul style="list-style-type: none"> <li>Refrigerator has heat-proof piping in the interior wall.</li> </ul>	<ul style="list-style-type: none"> <li>To prevent condensation from forming, the refrigerator has heat-proof piping in the front corners. If the ambient temperature rises, this equipment may not work effectively. This is not a system failure.</li> </ul> 

# Troubleshooting

## Odours

Symptom	Possible causes	Solution
Refrigerator has odours.	• Spoiled food.	• Clean the refrigerator and remove any spoiled food.
	• Food with strong odours.	• Make sure strong smelling food is wrapped airtight.

## Condensation

Symptom	Possible causes	Solution
Condensation forms on the interior walls.	• If door is left open, moisture enters the refrigerator.	• Remove the moisture and do not open the door for a long time.
	• Food with high moisture content.	• Make sure food is wrapped airtight.

## Water/Ice (Auto Ice Maker models only)

Symptom	Possible causes	Solution
The ice maker does not produce ice.	• The freezer room is not cold enough.	• Make sure the cold air outlet is not clogged.
	• The wire connector of the ice maker is not connected properly.	• Make sure the wire connector from the wire housing is connected properly.
	• The water line flowing to the ice maker is bent or kinked.	• Make sure the water line in the rear of the refrigerator is not bent or kinked.



## Do you hear abnormal sounds from the refrigerator?

Before calling for service, review the checkpoints below. Any service calls related to normal sounds will be charged to the user.

### These sounds are normal.

- When starting or ending an operation, the refrigerator may make sounds similar to a car engine igniting. As the operation stabilizes, the sounds will decrease.

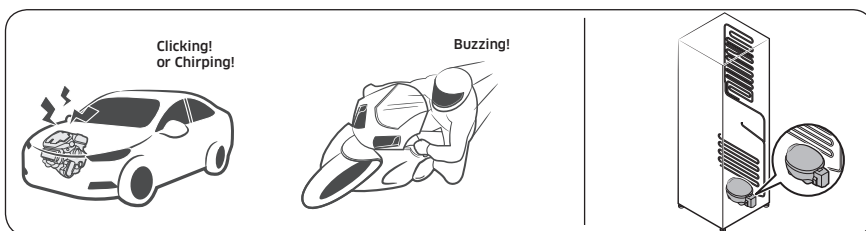

- While the fan is operating, these sounds may occur. When the refrigerator reaches the set temperature, no fan sound will occur.



- During a defrost cycle, water may drip on the defrost heater, causing sizzling sounds.



# Troubleshooting

- As the refrigerator cools or freezes, refrigerant gas moves through sealed pipes, causing bubbling sounds.

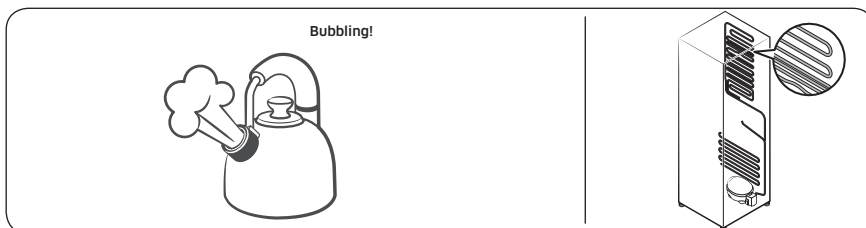

- As the refrigerator temperature increases or decreases, plastic parts contract and expand, creating knocking noises. These noises occur during the defrosting cycle or when electronic parts are working.

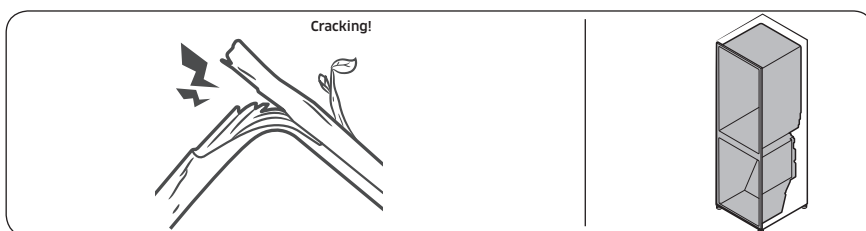

- For ice maker models: When the water valve opens to fill the ice maker, buzzing sounds may occur.
- Because of pressure equalizing when opening and closing the refrigerator door, whooshing sounds may occur.

## SmartThings (applicable models only)

Symptom	Action
Could not find "SmartThings" in the app market.	<ul style="list-style-type: none"> <li>The supporting software version of the SmartThings app is subject to change according to the OS supporting policy the manufacturer provides. In addition, as for the SmartThings app or the functions that the app supports, the new application update policy on the existing OS version can be suspended due to usability or security reasons.</li> </ul>
The SmartThings app fails to operate.	<ul style="list-style-type: none"> <li>The SmartThings app is available for applicable models only.</li> <li>The old Samsung Smart Refrigerator app cannot connect with Samsung Smart Home models.</li> </ul>
The SmartThings app is installed but is not connected to my refrigerator.	<ul style="list-style-type: none"> <li>You must log into your Samsung account to use the app.</li> <li>Make sure that your router is operating normally.</li> <li>If the Wi-Fi icon on the refrigerator's display is off, this indicates that no network connection has been established yet. In this case, use the SmartThings app to connect and register your refrigerator to the access point (AP) of your house.</li> </ul>
Could not log into the app.	<ul style="list-style-type: none"> <li>You must log into your Samsung account to use the app.</li> <li>If you don't have a Samsung account, follow the app's onscreen instructions to create one.</li> </ul>
An error message appears when I try to register my refrigerator.	<ul style="list-style-type: none"> <li>Easy Connection may fail due to the distance from your access point (AP) or electrical interference from the surrounding environment. Wait a moment and try again.</li> </ul>
The SmartThings app is successfully connected to my refrigerator but does not run.	<ul style="list-style-type: none"> <li>Exit and restart the SmartThings app, or disconnect and reconnect the router.</li> <li>Power off the refrigerator, and then power it on again after 1 minute.</li> </ul>
The Wi-Fi icon is blinking. (📶)	<ul style="list-style-type: none"> <li>Connect your refrigerator with the SmartThings app before use. When the connection is made successfully, the indicator stops blinking.               <ul style="list-style-type: none"> <li>If you fail to make connection or don't want to use the app, press and hold the <b>Fridge</b> button for 10 seconds. The indicator stops blinking.</li> </ul> </li> </ul>

# Open Source Announcement

---

The software included in this product contains open source software.

The following URL [http://opensource.samsung.com/opensource/SMART\\_TP1\\_0/seq/0](http://opensource.samsung.com/opensource/SMART_TP1_0/seq/0) leads to open source license information as related to this product.



# Memo

---

## Contact SAMSUNG WORLD WIDE

If you have any questions or comments relating to Samsung products, please contact the SAMSUNG customer care centre.

Country	Contact Center	Web Site
NEW ZEALAND	0800 726 786 (All Product) 0800 6 726 786 (Support for Smart Mobile Devices)	<a href="http://www.samsung.com/nz/support">www.samsung.com/nz/support</a>
INDIA	1800 40 SAMSUNG (1800 40 7267864) (Toll-Free) 1800 5 SAMSUNG (1800 5 7267864) (Toll-Free)	<a href="http://www.samsung.com/in/support">www.samsung.com/in/support</a>
MALAYSIA	1800-22-8899 (HHP) 1800-88-9999 (OTH) +603-7713 7420 (Overseas contact)	<a href="http://www.samsung.com/my/support">www.samsung.com/my/support</a>
PHILIPPINES	Dedicated Hotline for Mobile Phones: #GALAXY (just dial #425299)  All Products : 1-800-10-7267864 [ PLDT - Toll Free ] 1-800-8-7267864 [ Globe - Toll Free ] 84222111 [ Landline ]	<a href="http://www.samsung.com/ph/support">www.samsung.com/ph/support</a>
SINGAPORE	1800 7267864   1800-SAMSUNG (Other) 1800 4252997   1800-GALAXYS (HHP)	<a href="http://www.samsung.com/sg/support">www.samsung.com/sg/support</a>
PANAMA	800-0101	<a href="http://www.samsung.com/latin/support">www.samsung.com/latin/support</a> (Spanish) <a href="http://www.samsung.com/latin_en/support">www.samsung.com/latin_en/support</a> (English)
SOUTH AFRICA	0860 SAMSUNG (726 7864)	<a href="http://www.samsung.com/za/support">www.samsung.com/za/support</a>
UK	0333 000 0333	<a href="http://www.samsung.com/uk/support">www.samsung.com/uk/support</a>
IRELAND (EIRE)	0818 717100	<a href="http://www.samsung.com/ie/support">www.samsung.com/ie/support</a>
MYANMAR	+95-1-2399-888 VIP HHP +95-1-2399-990	<a href="http://www.samsung.com/mm/support">www.samsung.com/mm/support</a>
SRI LANKA	011 SAMSUNG (011 7267864)	<a href="http://www.samsung.com/in/support">www.samsung.com/in/support</a>
BANGLADESH	08000-300-300 (Toll free) 09612-300-300	<a href="http://www.samsung.com/bd/support">www.samsung.com/bd/support</a>



DA68-04657J-01